

Paneeliasennetut pistorasia TwinCONTACT

Osanro 1797



- ruuvittomat jousiliittimet
- soveltuu läpijohtotukseen
- suora

Tekniset tiedot

Virta	32 A
Napaluku	5 p
Volt	400 V
Kelloasento	6 h
Hertz	50-60 Hz
Liitinteknologia	Ruuviton - TwinCONTACT
Kosketin	vakio
Suojaustyyppi	IP44
Laippa	75x75 mm
Kiinnitysreikä	60x60 mm
Paino	213 g
Yhdenmukaisuusvakuutus	VDE, EAC, CQC

Mitat

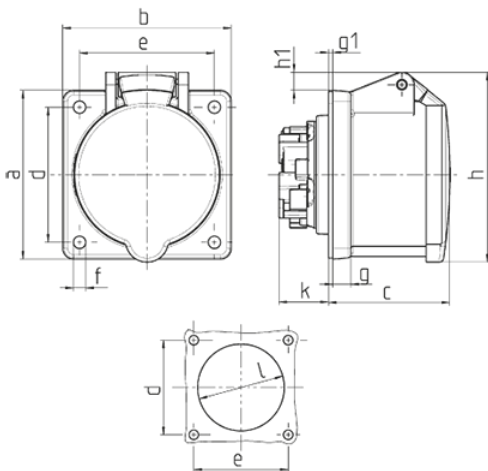

Drawing 1 MB 464	Amp. Poles	16			32		
		3	4	5	3	4	5
Dim. in mm	a	75	75	75	75	75	75
	b	75	75	75	75	75	75
	c	53	53	54	64	64	64
	d	60	60	60	60	60	60
	e	60	60	60	60	60	60
	f	5.5	5.5	5.5	5.5	5.5	5.5
	g.	8	8	8	8	8	8
	g.1	2	2	2	2	2	2
	h	75	80	85	89	89	95
	h1		5	8	10	10	12
	k	22	22	22	28	28	28
	l	43	52	57	60	60	64
	Terminal for cond. cross section (mm ²) min.-max.	1.5	1.5	1.5	2.5	2.5	2.5
		-4	-4	-4	-6	-6	-6