

Wall mounted receptacle DUOi

Part Number.: 5612506G



MENNEKES

Elektrotechnik GmbH & Co. KG
Aloys-Mennekes-Straße 1
57399 KIRCHHUNDEM GERMANY
www.MENNEKES.org

Product Description

- screw terminals
- LED voltage indicator
- pre-wired for installation
- X-CONTACT
- switched
- mechanical DUO-interlock
- 3 pole switch
- receptacles can be padlocked
- sealed against dust, temporary submersion and high pressure cleaning

Technical Details

Wall mounted receptacle - DUO	5612506G
Product series	DUOi
Switch Disconnecter	Yes
Ampere	16A
Number of Poles	5 P
Clock position	6 h
Voltage	400 V
Hertz	50-60 Hz
Current Type	AC
Switch Type	3P + N + PE
Protection Type	IP67/IP69
Impact resistance	IK08
Contact carrier	Highly heat resistant X-CONTACT®
Pilot contact	Without pilot contact
Connection	Screw-terminals
LED voltage indicator	Yes

	Life expectancy: 10 years at ambient temperature +40 °C
Padlocked	Yes
Mounting method	Wall mounted
Cable entry	Top & Bottom 2 x M25 top or bottom closed 1 x M25 and 1 x M32 top or bottom closed
Weight (net)	1340 g
EAN / identification number	4015394304029

Permissible ambient conditions

Permanent ambient temperature min. - max.	-25 - +40 °C
---	--------------

Material properties

Hinged lid	PA6/TPE similar RAL 3013 red similar RAL 7016 anthracite
Upper enclosure part	PC/ASA similar RAL 7035 grey
Enclosure base	PC/ASA similar RAL 9005 deep black
Rotary Switch	PC/ASA similar RAL 7035 grey
Material of exterior screws	PA6 similar RAL 9005 deep black

Material resistance

The material resistance overview can be found on the website in the "Knowledge" section → "Product knowledge" → "Materials"

Regulations and Standards

REACH (Regulation (EG) No. 1907/2006)	Information according to article 33 REACH: SVHC: Lead (CAS: 7439-92-1)
RoHS 2011/65/EU incl. 2015/863/EU	✓
POP Regulation (EU) 2019/1021	✓
Norm(s)	IEC 60309-4
Declaration of conformity	CE, UKCA
Test mark	VDE

Dimensional drawing

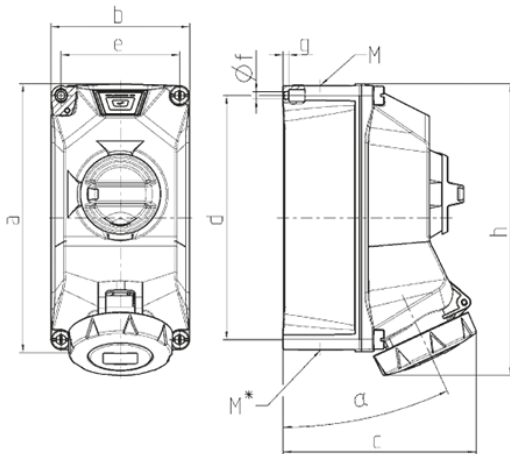

Drawing 1 MB 716	Amp. Poles	16			32		
		3	4	5	3	4	5
Dim. in mm	a	225	225	225	225	225	225
	b	118	118	118	118	118	118
	c	163	163	165	168	168	169
	d	208	208	208	208	208	208
	e	101	101	101	101	101	101
	f	6.4	6.4	6.4	6.4	6.4	6.4
	g	5	5	5	5	5	5
	h	241	245	249	252	252	255
	α		25			25	
	M	1x25 and 1x32			1x25 and 1x32		
	M*	2x25	2x25	2x25	2x25	2x25	2x25
	Max. cable diam. (mm)	25	25	25	25	25	25
	Terminal for cond. cross section (mm ²) min.-max.	2.5	2.5	2.5	2.5	2.5	2.5
		-10	-10	-10	-10	-10	-10